

DETAIL A

**SALLE DE LAVAGE**  
MODELE L  
DISPONIBLE  
12" - 16" - 20"  
1 TABLETTE

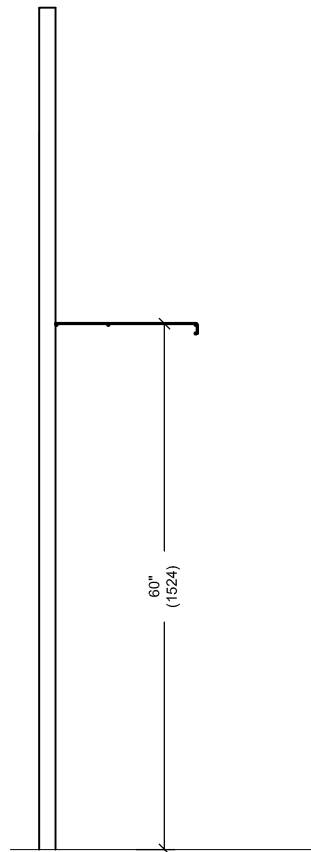

DETAIL B

**SALLE DE LAVAGE**  
MODELE L  
DISPONIBLE  
12" - 16" - 20"  
2 TABLETTES

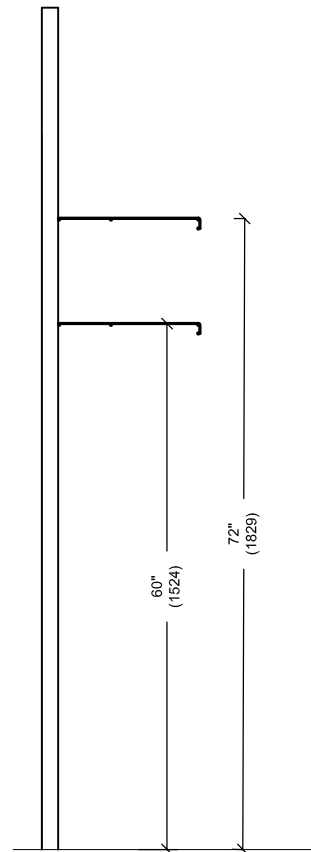

DÉTAIL C

**RANGEMENT**  
MODELE L OU TM  
DISPONIBLE  
12" - 16" - 20"  
1 TABLETTE

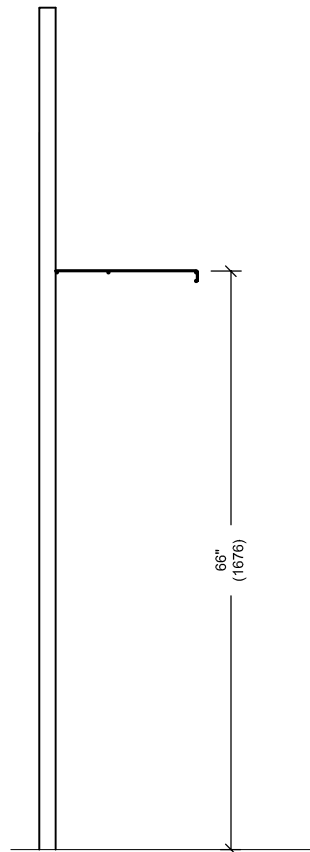

DÉTAIL D

**GARDE MANGER  
OU LINGERIE**  
MODELE L OU TM  
DISPONIBLE  
12" - 16" - 20"  
4-5 TABLETTES

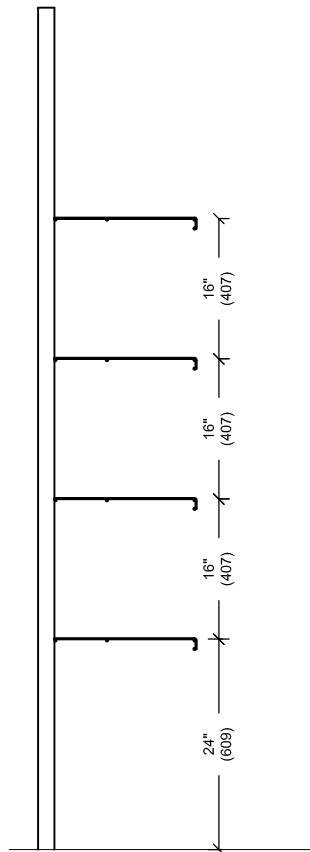

DÉTAIL E

**GARDE-ROBE**  
MODELE OS OU SR  
DISPONIBLE  
12" - 16" - 20"  
1 TABLETTE

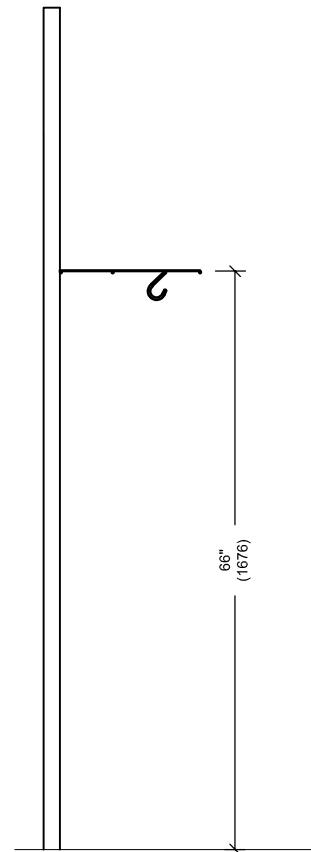

DÉTAIL F

**GARDE-ROBE**  
MODELE OS OU SR  
DISPONIBLE  
12" - 16" - 20"  
2 TABLETTES

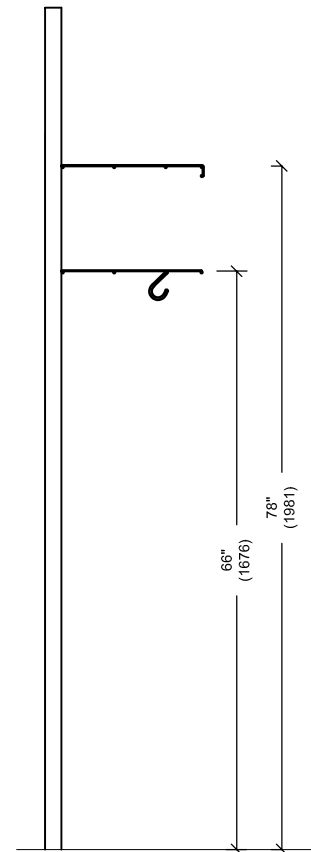

DÉTAIL G

**GARDE-ROBE**  
MODELE OS OU SR  
DISPONIBLE  
12" - 16" - 20"  
2 TABLETTES

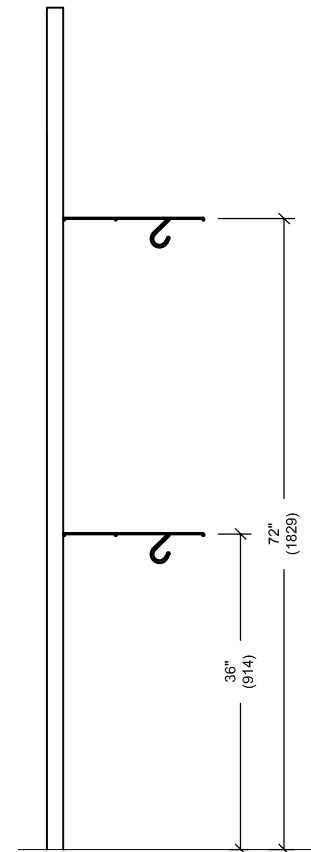

PROJET:  
RÉF

CLIENT:

# GUIDE D'INSTALLATION DE TABLETTES GRILLAGÉES

**PROJET DÉPÔT**  
1-1284 1ere rue du Parc-Industriel  
Sainte-Marie, QC G6E 1H4  
418-389-4853  
MARYLEE LEBLOND  
WWW.PROJETDEPOT.COM